

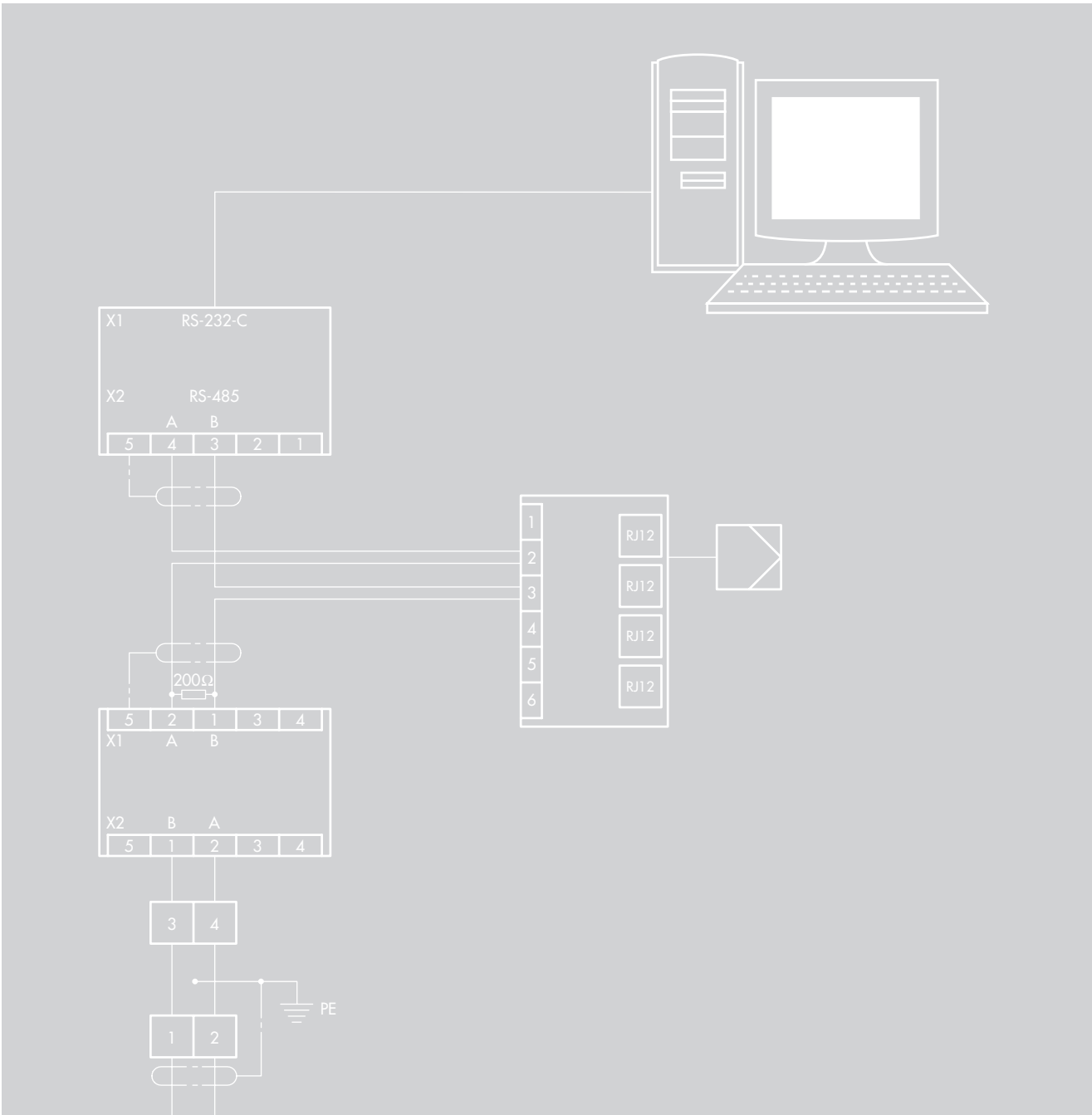





Field of application:
TROVIS 5500, TROVIS 6400 and TROVIS 6600 Automation Systems



Type/order number	CoRe01 1400-9670	1400-9867	DataMod 11 1400-8801	
Device type	Universal bus unit	Meter bus/Modbus gateway	Multi-function modem	
				
Line splitter: Division into RS-232 and RS-485 signals			•	
Converter: Conversion of RS-232 into RS-485 signal	•			
Repeater: Amplification of RS-485 signal	•			
Conversion from four-wire into two-wire	•			
Use in two-wire network (RS-485)	•		•	
Use in four-wire network (RS-485)	•		•	
Integrated bus termination (200 Ω)	•		•	
Monitoring of transmission time (for data transmitted to control station)	•			
Integrated interface converter RS-232 into RS-485 (two-wire)				
Device bus connection over modem			•	
Analog telephone line			•	
Notification by text message (SMS)			•	
Modbus-TCP				
Meter bus		•		
Linking of serial ports (RS-232, TTL, RS-422/485) to TCP/IP networks				
Surge protection RS-485 with one RJ-12 or RJ-45 connector socket				
Surge protection RS-485 with two RJ-12 connector sockets				
Operating voltage 230 V AC/power supply unit	•	•		
Operating voltage 5 V DC (supplied by the controller)			•	
For wall mounting				
For top-hat rail mounting	•	•	•	
Accessories: Hub with single RJ-12 port				
Accessories: Hub with four RJ-12 ports				
Additional information	TV-SK 6374	–	TV-SK 6324	

Universal bus unit CoRe01**1400-9670**

The unit can be used as a converter (RS-232 to RS-485) or as a repeater for RS-485 buses in two-wire or four-wire technology.

Slide switches accessible from the outside allow operators to select the operating mode, transmission rate, termination and bus bias voltage.

In two-wire operation, the polarity of the two wires does not need to be observed, provided this applies to all other devices on the bus as well.

Both interfaces are isolated against the microcontroller (signal processing unit) located in between them. The interfaces do not need to be used in the same operating mode, e.g. one interface can be operated in two-wire connection with 19,200 bit/s and the other in four-wire connection with 9,600 bit/s. Despite connecting several repeaters in succession, the signal does not increasingly degenerate.

A safety mechanism (transmission time monitoring) prevents the bus line from being permanently blocked.

Multi-function modem DataMod 11**1400-8801**

The multi-function modem allows data to be transmitted between a control station and TROVIS 5500 Controllers over a long distance using public telephone networks. The built-in line splitter enables several controllers to be addressed in one common phone link without the use of a coupling computer.

The multi-function modem has three ports (RS-232, TTL and RS-485). Alarms can be sent as text messages to a mobile phone, provided the controller supports this function.

Accessories**USB/RS-232 adapter****8812-2001****Communication cable****1400-7419**

- Approx. 1.5 m
- 9-pin SUB-D connector and RJ-12 connector

Programming cable**1400-7620**

- Approx. 1.5 m
- 9-pin SUB-D connector and RJ-45 connector

Four-port bus hub**1400-7140**

- For rail mounting
- Four RJ-12 ports

Bus connecting cable RJ-12/RJ-12

- Connector/connector

- 0.8 m

8801-2804

- 1.6 m

8801-2805

- 3 m

8801-2806**RS-232/RS-485 four-wire cable converter****1400-7308**

- Length: 1.5 m

RS-232/RS-485 2-wire cable converter**1400-8800**

- Length: 1.5 m

Universal bus unit CoRe01		
Interfaces	Bottom interface	Connection towards master (control station) – RS-232 or RS-485 (two-/four-wire) can be configured using switches – RS-232: Connection to computer using SAMSON adapter (1400-7620) – RJ-45 connector socket or screw terminals can be used
	Top interface	Connection towards slave (other bus, to controller) – RS-485 (two-/four-wire) can be configured using switches – Optionally, RJ-11 connector socket and/or screw terminals can be used
Transmission rate		9600 bit/s, 19200 bit/s
Voltage supply		165 to 250 V, 48 to 62 Hz using plug-in screw terminals
Terminals		Max. 2.5 mm ² or 2 x 1.0 mm ² wire cross-section
LEDs		Indication of operation, two-wire operation, transmit and receive data (to controller and building control station), activity of RS-485 driver, direct mode
EMC	Noise immunity	According to EN 61000-6-2
	Noise emission	According to EN 61000-6-3
Ambient temperature		0 to 50 °C
Housing		Plastic housing (PA6)
Dimensions W x H x D		Approx. 67 x 43 x 25 mm
Mounting		Mounting on a 35 mm top-hat rail according to DIN EN 50022

Communication

Two versions (four-wire or two-wire system) are available for the communication with the RS-485 bus signal level between various components in a centrally controlled system.

The two-wire system has two bidirectional data lines to transmit data (TD) and to receive data (RD).

The four-wire system has four unidirectional data lines, two lines to transmit data (TD) and two lines to receive data (RD).

Network structure (see following pages)

First connect the converter to the computer to convert the RS-232-C signal from the computer into the RS-485 bus signal level. Should the total line length exceed 1,200 m or more than 32 stations are connected to the bus, a repeater must be used. It is not recommendable to use more than five repeaters connected in series. The bus lines should branch directly at the bus participant, if possible, or at the hub. If this is not the case, a repeater must be used. A bus termination must be used at the beginning and end of each physical line in order to discharge any interference voltage.

Lightning and overvoltage protection

Upon installation, observe the relevant standards and regulations governing lightning and overvoltage protection. For data transmission lines running between buildings, lightning and overvoltage protection must be ensured by the appropriate measures. In addition, sufficient equipotential bonding must be guaranteed. We recommend the use of the following modules to protect the data transmission lines:

- Surge arrester SA 1000, SA 5000, SAC055 or Blitzductor® XT Types BXT ML2 BE S 5 or BXT ML4 BE 5, by Dehn or equivalent product
- M-Bus: Blitzductor® XT Types BXT ML2 BDS 48 or BXT ML4 BD 48, by Dehn or equivalent product
- 230 V network: DEHNguard® S Type DGT 275 by Dehn or equivalent product

TV-SK 6364 contains additional information.

Installing bus line and shielding

Make sure the bus lines are installed correctly to avoid any possible disturbances.

- Properly shield the bus cable (shielding must be used on both sides and cover a large area)
- Connect the bus devices over the shortest distance
- Reduce different potentials by using sufficient equipotential bonding, otherwise transient currents can be conducted over the shielding!

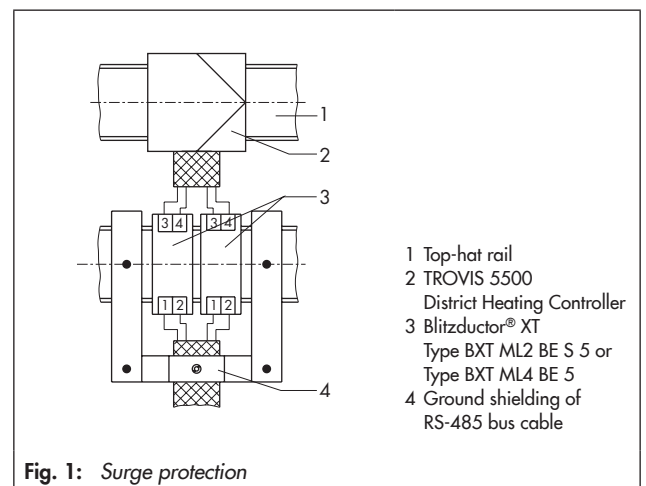

Bus protocol

SAMSON devices belonging to the Series TROVIS 5500, TROVIS 6400 and TROVIS 6600 communicate using the bus protocol, Modbus RTU.

Modbus protocol description	
Specification	Modbus application protocol specification V1.1a
Protocol name	Modbus
Protocol format	RTU (remote terminal unit)
Protocol principle	Master/slave
Max. word length	2 bytes
Max. block length	256 bytes
Data integrity check	CRC-16
Ranges	
Address range	0 to 255
Standard addresses	1 to 247
Special addresses	0 and 248 to 255
Register range	0001 to 9999
Supported function codes for TROVIS 6600	1, 2, 3, 4, 5, 6, 15, 16
Supported function codes TROVIS 5500, TROVIS 6400	1, 3, 5, 6, 15, 16
Data transmission	
Standard format	1 start bit, 8 data bits, 1 stop bit, no parity (8N1)
Transfer rates	Up to 19200 Baud (standard: 9600 Baud)
Transmission standard	RS-485, RS-422, four-wire/two-wire bus
Driver load	> 54 Ω
RS-485 line termination	200 Ω between receiver lines
Transmission medium	Screened twisted pair (STP, AWG 24) Resistance < 100 Ω /km, capacitance < 100 nF/km
Topology	
Bus topology	Line, with stubs separated by repeaters
Number of bus devices	Max. 32/126 (including repeater or converter) per segment with four-wire/two-wire system
Number of repeaters	Max. 5 in series
Stub length (branch)	Max. 3 m
Segment length	Max. 1200 m
Bus range	Max. 7200 m, greater distances on request

Communication network structure

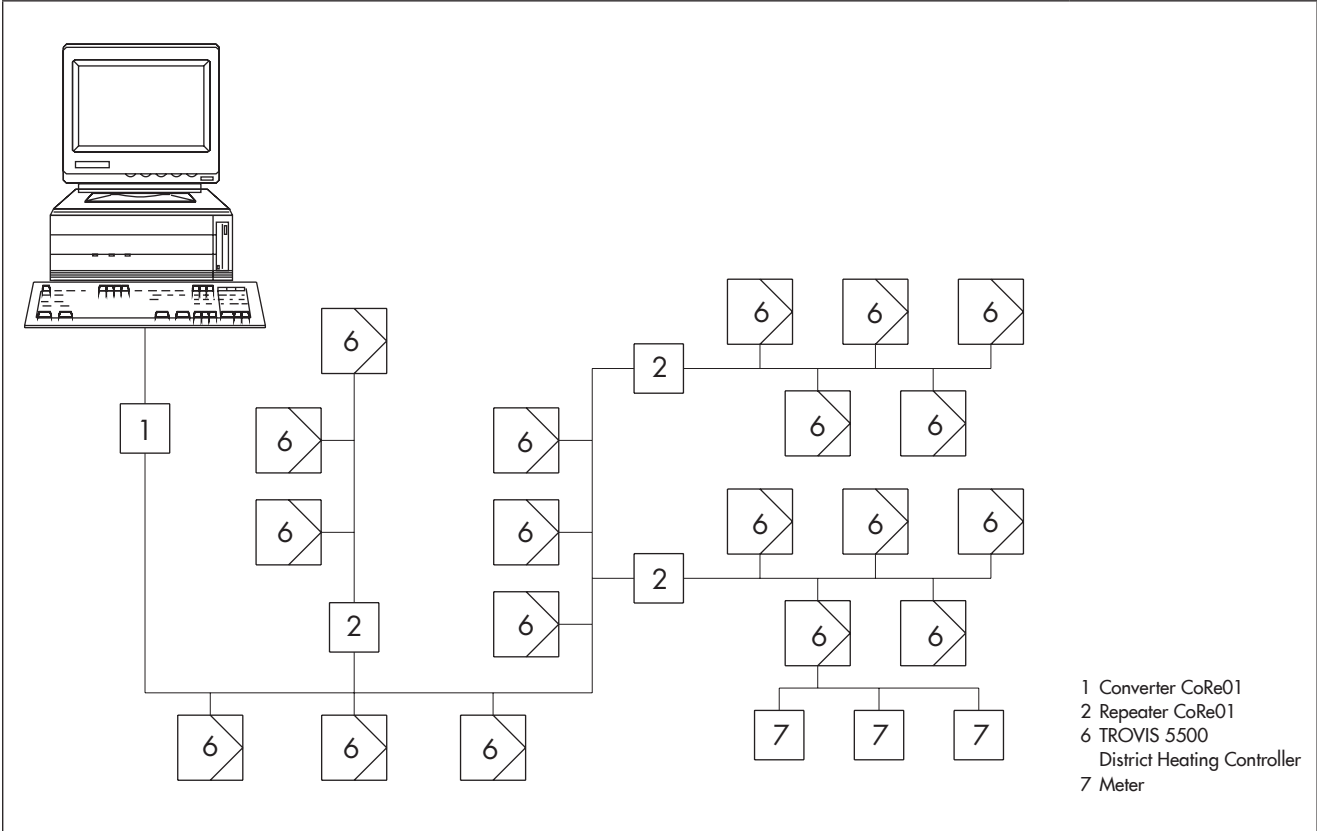

Wiring plan for two-wire bus with universal bus unit CoRe01

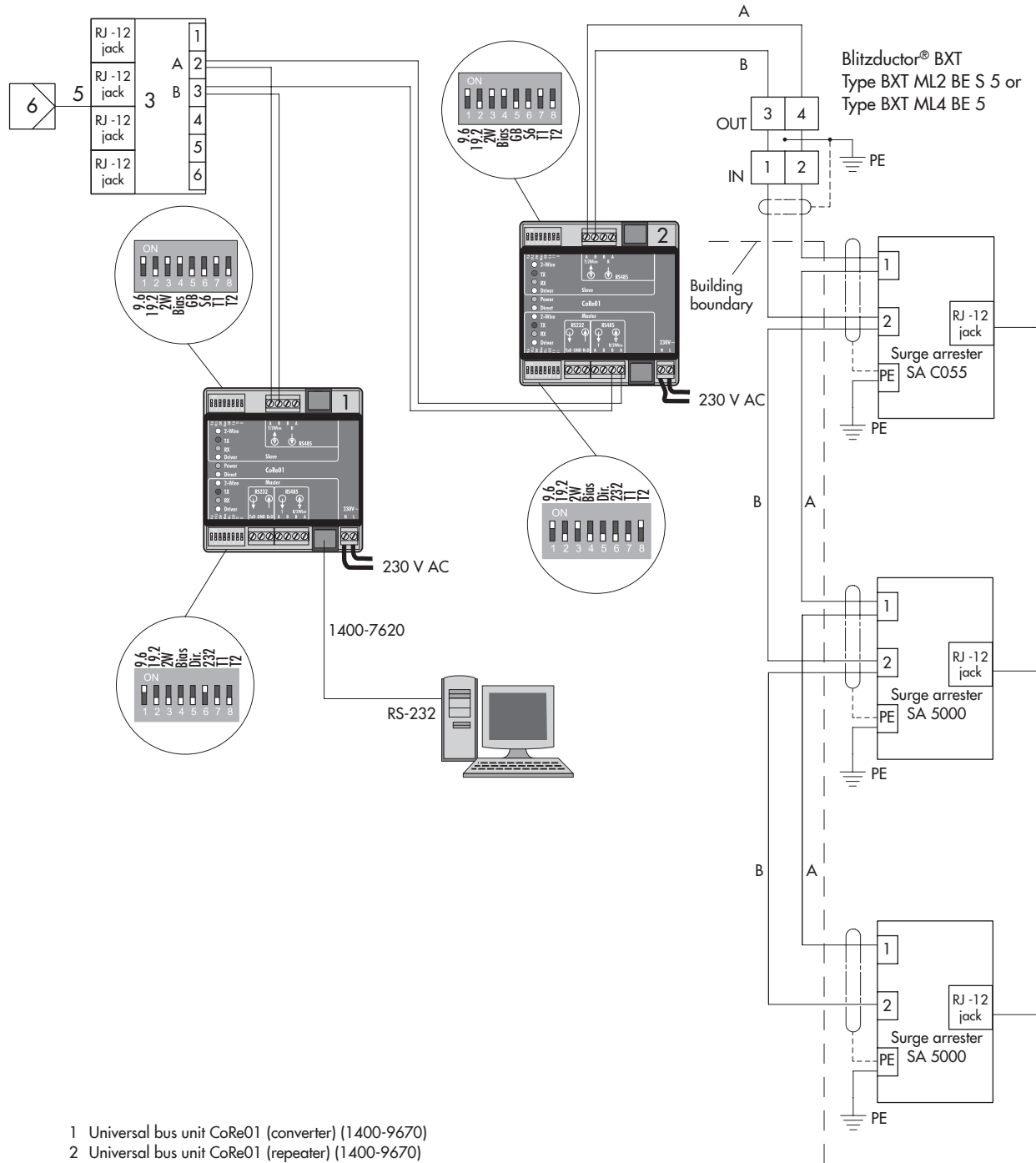

- 1 Universal bus unit CoRe01 (converter) (1400-9670)
- 2 Universal bus unit CoRe01 (repeater) (1400-9670)
- 3 Four-port bus hub (1400-7140)
- 4 Bus connecting cable (8801-280x)
- 5 Cable converter (1400-8800)
- 6 TROVIS 5576, 5579 District Heating Controller
- 7 M-Bus meter (EN 1434-3)
- 8 Patch connecting cable

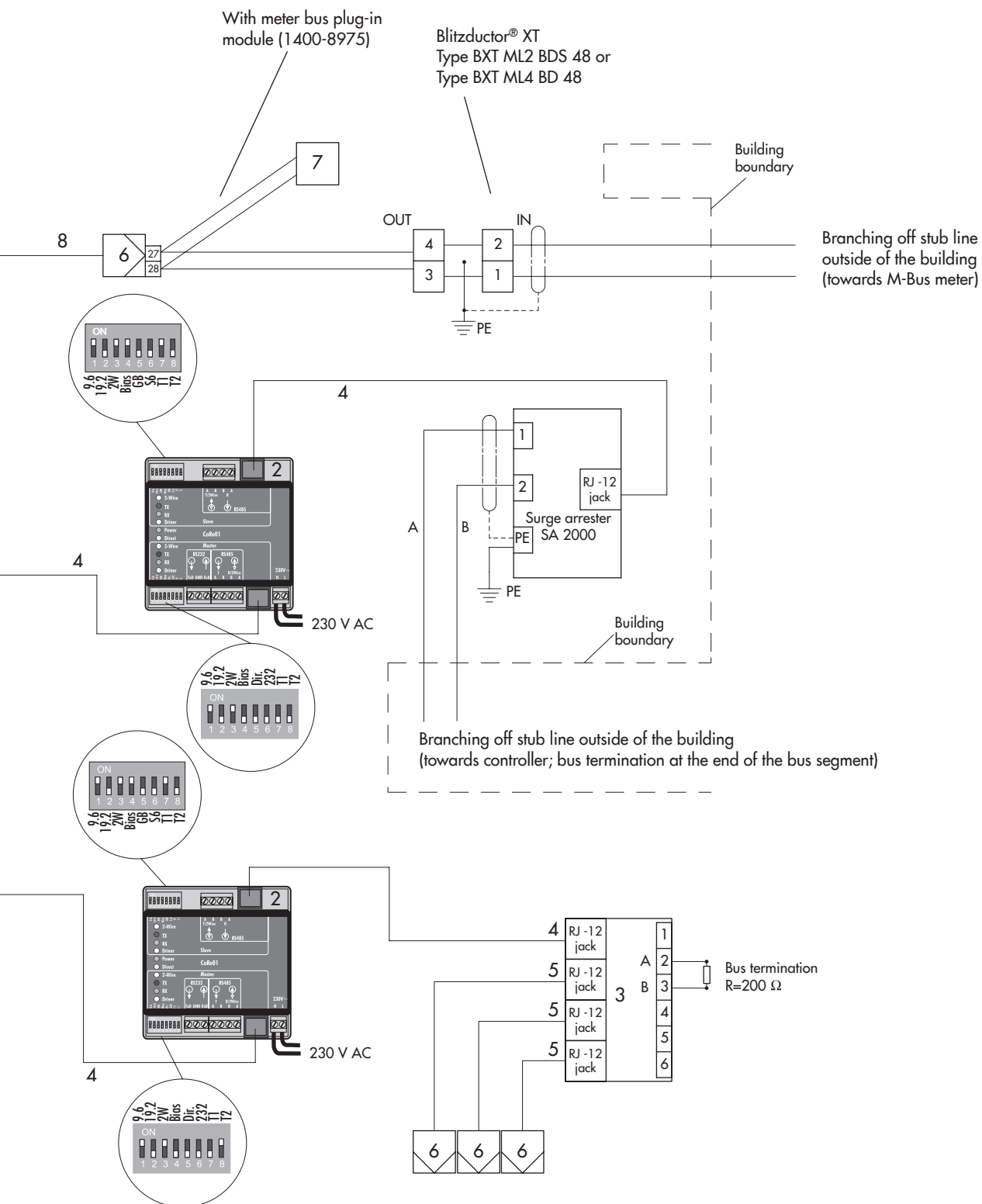

Wiring plan for four-wire bus with universal bus unit CoRe01

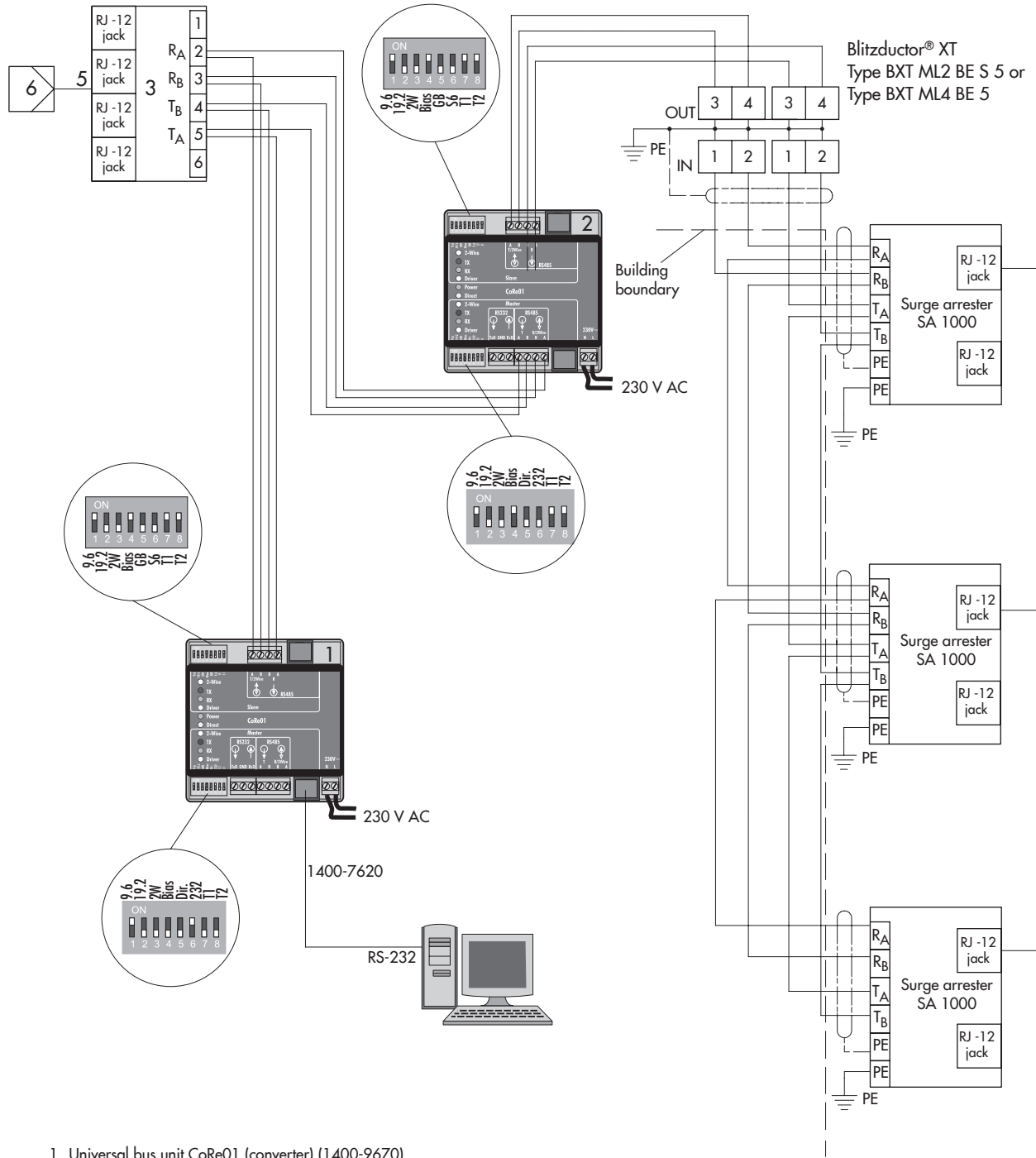

- 1 Universal bus unit CoRe01 (converter) (1400-9670)
- 2 Universal bus unit CoRe01 (repeater) (1400-9670)
- 3 Four-port bus hub (1400-7140)
- 4 Bus connecting cable (8801-280x)
- 5 Bus connecting cable (8801-280x) or cable converter (1400-7308) (depending on controller)
- 6 TROVIS 5576, 5579 District Heating Controller
- 7 M-Bus meter (EN 1434-3)

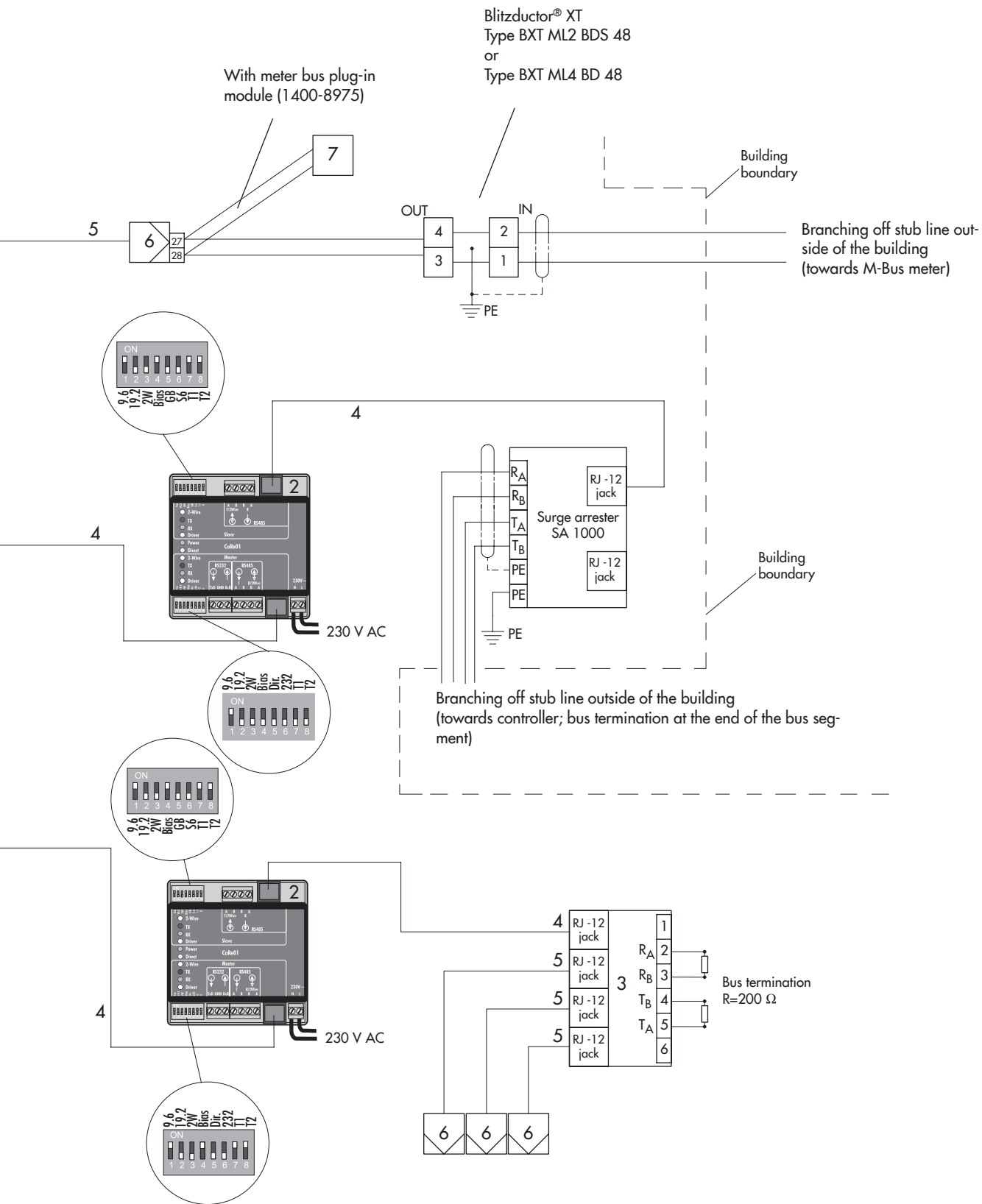

Specifications subject to change without notice



SAMSON AG · MESS- UND REGELTECHNIK
Weismüllerstraße 3 · 60314 Frankfurt am Main, Germany
Phone: +49 69 4009-0 · Fax: +49 69 4009-1507
samson@samson.de · www.samson.de

T 5409 EN

2015-04-28 · English